



www.europort.no



INDUSTRIPORTEN

STÅL OG ALUMINIUM

type TL 400 / TL - Full View





Leddheisporter for industri, Type TL-400



Standard industriport,
40 mm isolering $k=0,4W/m^2$

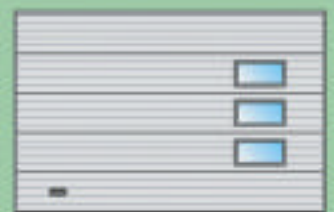
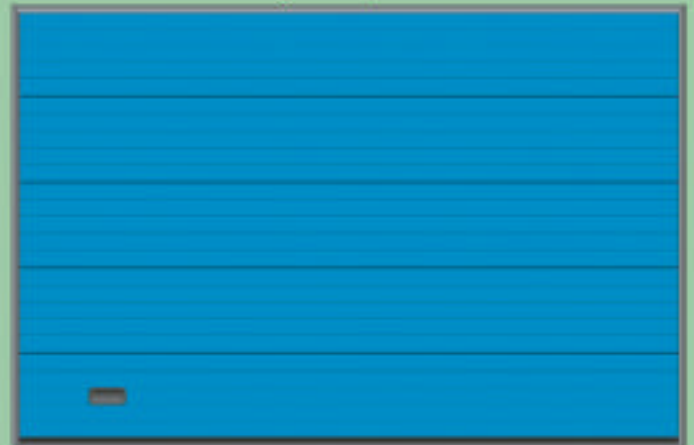

Eksempler på vindusplassering

Lameller

Isolerte lameller med horisontal panel i attraktiv stucco-preg.
ISO 9001 sertifisering iht. CE EN 12453.
Karmer m/ beskyttelse mot fingerinngrep både inn- og utvendig.
Fall- og fjærbruddsikring. Fingerklemsikring.
40 mm CFC fri polyurethan hardskumkjerne.
Fjærer for 25.000 sykluser.
Dra-snor for manuell åpning og lukking.
Låsing innvendig med skyvebolt i skinne.
Utvendig håndtak. Galvaniserte skinner og beslag.

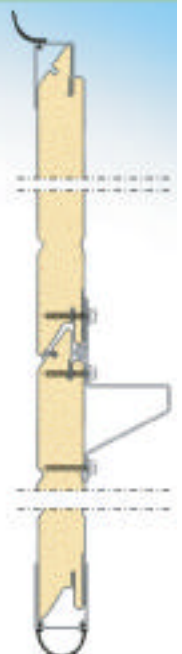
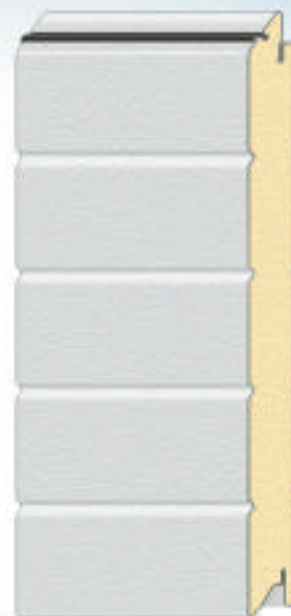

Leddheiseport i aluminium "Full View"

Industriporter med vinduer og gangdør



Industriport "Full View"



Aluminium "Full View" leveres med dobbelt acrylglass. Bunnlamell: Sandwich. Stødig og attraktiv port!

Ledd med fingerklemsikring. Beskytter mot fingerklemming både ut- og innvendig.

Kan også leveres med:

- Motordrift
- Andre typer beslag
- Forskjellige vindusalternativer
- Gangdør
- Kundespesifiserte løsninger

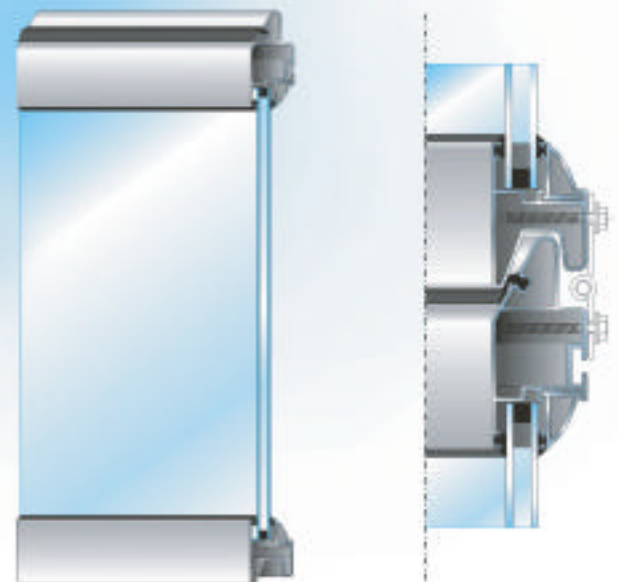

Stort utvalg av beslagsystemer. (kan også kundespesifiseres)

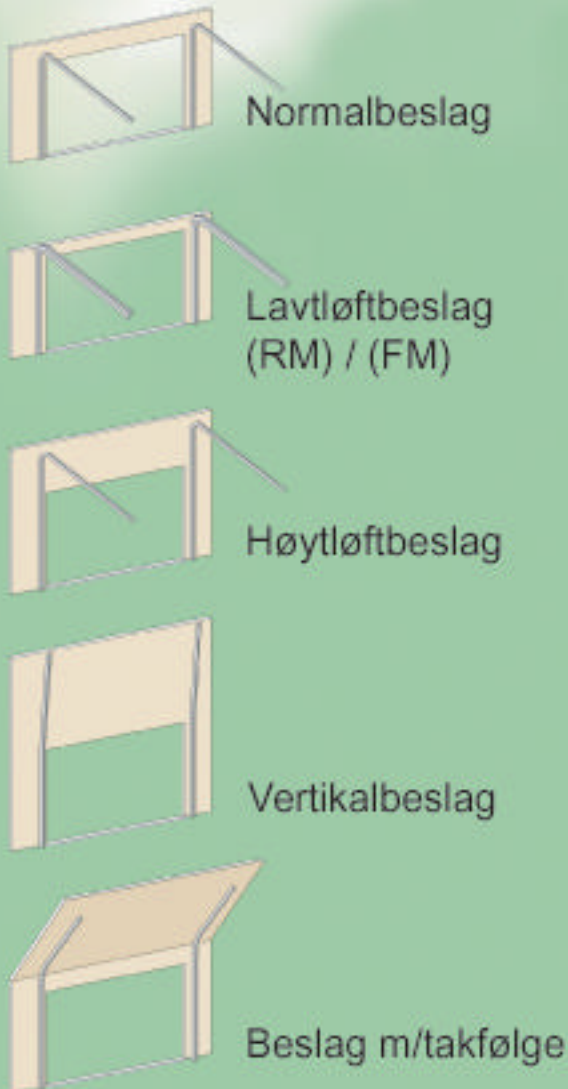

Overflatebehandling

1. Polyurethanskum
2. Profilert stålplate
3. Varmdyppet galvanisering
4. Primer
- 5-6. Polyesterlakkering

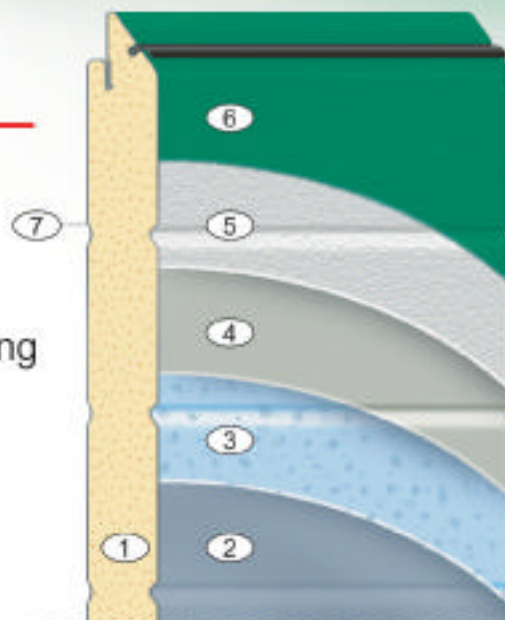

Vindusalternativer (dobbelt acrylglass)



Rundt vindu



Ovalt vindu



Rektangulært vindu

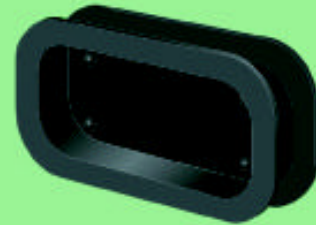

Håndtak



Gjennomgående lås

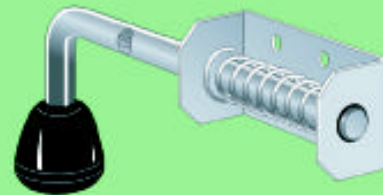

Låsbolt i skinne

Tettelister i topp, bunn og sider

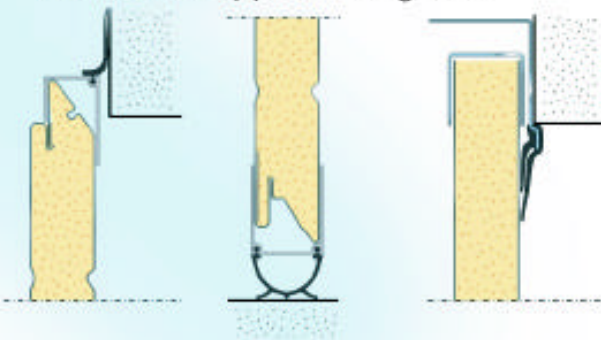

Fargealternativer:

Alle RAL-farger i tillegg til kundespesifiserte farger





Kvalitetsdeler i galvanisert utførelse

www.europort.no



Håndkjedetrekk
(for manuell betjening)

Bunnkonsoll

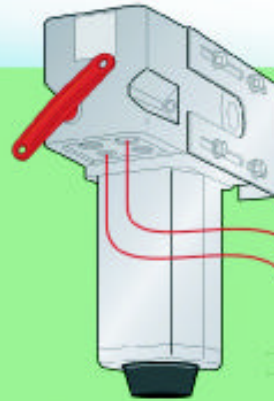

"Ovitor" gearmotor.
Motorisert betjening
av port, med frikobling



Fallsikring



Sidehengsler
med løpehjul

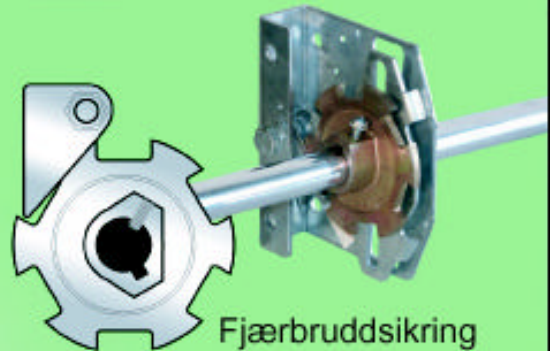

Fjærbruddsikring



Forhandler: _____